

COM-PAK

# EnergyPlus

MORE COMFORT, LESS ENERGY



Thank you for your purchase! Question or problem? Let us solve it with a single phone call, email or online chat! We'll save you a trip back to the store!

### Cadet Customer Service

Phone: **855.CADET.US** (855.223.3887)

email: [customerservice@cadetheat.com](mailto:customerservice@cadetheat.com)

Live chat: [cadetheat.com](http://cadetheat.com) (contact us)

For how-to videos or more information, please visit:

<http://cadetheat.com/install/energyplus>



[cadetheat.com](http://cadetheat.com)

855.CADET.US

Vancouver, Washington



tested to UL standards

# IMPORTANT INSTRUCTIONS

⚠ When using electrical appliances, basic precautions should always be followed to reduce the risk of fire, electric shock, and injury to persons, including the following:

1. Read all instructions before installing or using this heater.
2. This heater is hot when in use. To avoid burns, do not let bare skin touch hot surfaces. Keep combustible materials, such as furniture, pillows, bedding, papers, clothes, etc. and curtains at least 3 feet (0.9 meters) from the front of the heater and keep them away from the sides.
3. Extreme caution is necessary when any heater is used by or near children or invalids and whenever the heater is left operating and unattended.
4. Do not operate any heater after it malfunctions. Disconnect power at service panel and have heater inspected by a reputable electrician before reusing.
5. Do not use outdoors.
6. To disconnect heater, turn control(s) to off, and turn off power to heater circuit at main disconnect panel.
7. Do not insert or allow foreign objects to enter any ventilation or exhaust opening as this may cause an electric shock or fire, or damage the heater.
8. To prevent a possible fire, do not block air intakes or exhaust in any manner.
9. A heater has hot and arcing or sparking parts inside. Do not use it in areas where gasoline, paint, or flammable vapors or liquids are used or stored.
10. Use this heater only as described in this manual. Any other use not recommended by the manufacturer may cause fire, electric shock, or injury to persons.
11. This heater must be installed in a fixed, permanent location.

## SAVE THESE INSTRUCTIONS

### ⚠ KNOW YOUR VOLTAGE! ⚠

If you are uncomfortable working with electricity, running electrical supply wire or installing a circuit breaker, please consult a licensed electrician. Make sure power to the heater is turned off at the main disconnect panel whenever doing any work on a heater. Serious injury or electrocution can result from electric shock.

- The multi-volt CE163T and CE083T Energy Plus heaters are equipped with a smart sensor that will auto adjust to your voltage supply.

The CE162T can only be connected to 240 volts, and the CE168T can only be connected to 208 volts.

- **CHECK YOUR BREAKER!** If you're replacing an existing heater, check the labels of the old heater and use the same voltage.

#### single-pole breaker

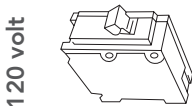

#### double-pole breaker

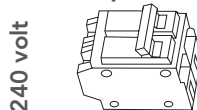

**WARNING:** Connecting a heater to a voltage higher than what's listed on its rating label will destroy the heater and could start a fire. A heater will not heat properly when connected to a voltage lower than what's listed on its rating label.

Unanswered questions? Call our technical support team in Vancouver, Washington toll free at **855.223.3887** or outside the USA **360.693.2505**

# INSTALLATION INSTRUCTIONS

- All electrical work and materials must comply with the National Electric Code (NEC), the Occupational Safety and Health Act (OSHA), and all state and local codes.
- Use copper conductors only.
- DO NOT install the heater directly above bathtub or sink. DO NOT install in shower stall area. Cadet recommends installing your heater at least 2 feet (61 cm) away to prevent contact with water.
- Heater must be connected to a GFCI protected branch circuit when installed in a bathroom.
- Heater must be installed in a wall can:  
Model CE - wall can model CC or CCSM
- DO NOT install the heater in a floor, in the ceiling, below a towel bar, behind a door, or anywhere the air discharge may be blocked in any manner.
- To reduce the risk of fire, do not store or use gasoline or other flammable vapors and liquids in the vicinity of the heater.
- Connect grounding lead to grounding screw provided. Keep all foreign objects out of heater.
- Electric heaters must be installed on a circuit dedicated to electric heaters, they cannot share a circuit with outlets, lights, or other appliances.
- CAUTION-High temperature, risk of fire, keep electrical cords, drapery, furnishings, and other combustibles at least 3 feet (0.9 m) from the front of the heater and away from the side and rear.

## TOOLS REQUIRED

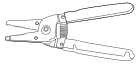

Wire Strippers



Wire Connectors



1 1/2" Wood Screws

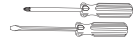

Straight and Phillips Screwdrivers



Drill and Drill Bits

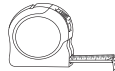

Tape Measure

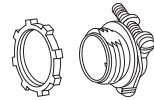

1/2" Cable Clamp Connector



Volt Meter

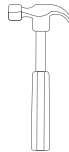

Hammer



Stud Finder

A multi-purpose tool or something to cut your existing drywall or gypsum board.

## PARTS OF YOUR HEATER

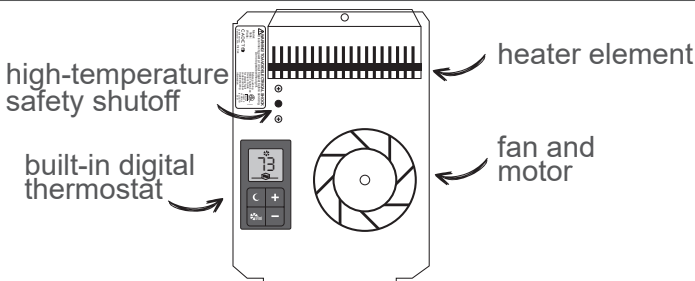

# INSTALLATION INSTRUCTIONS

## TIPS BEFORE YOU BEGIN

- **Verify power has been turned off before starting any work!**
- The Energy Plus can only be mounted with the element up. It cannot be mounted in the ceiling or in the floor. For multiple heater wiring, see page 6.
- For cleaner performance and longer heater life, install your heater 12 inches from the floor.
- All models can be installed to be Americans with Disabilities Act (ADA) compliant. Check your state and local requirements.
- A wall thermostat cannot be used with this heater. If you're replacing a heater controlled by a wall thermostat, watch our video here: <http://cadetheat.com/install/energyplus> to see how to remove it.
- The wall can label arrows show the correct mounting orientation (arrows must point up).

### STEP 1 Cut a hole in the wall next to a wall stud

If you haven't installed drywall yet, skip this step.

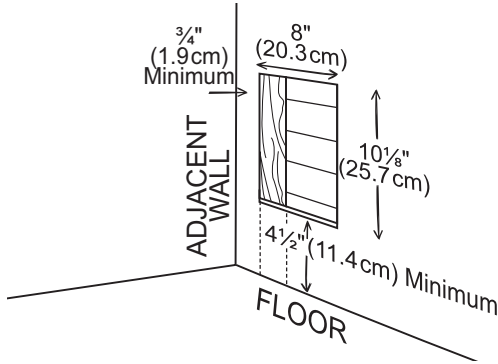

Figure 1

### STEP 2 Locate or route electrical supply wires

Route the electrical supply wire from the circuit breaker to the heater location.

Remove a knockout from the wall can and attach the supply wire with a cable clamp connector (not included) leaving a minimum of 6 inches wire lead (See Figure 2).

### STEP 3 Mount the wall can

If you haven't installed drywall yet, make sure the front of the wall can extends beyond the front edge of the wall stud to match the drywall depth (See Figure 2).

If you already have drywall installed, place the can into the cutout so the front is flush with the drywall.

Fasten the wall can to the stud with two screws through holes provided in the wall can (See Figure 2). As an option, the foam pad provided may be attached to the side of the wall can to square the wall can to the stud.

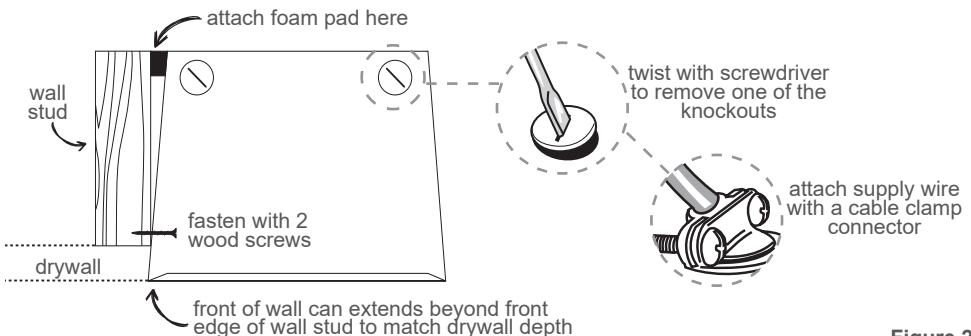

Figure 2  
View from top of wall can

# INSTALLATION INSTRUCTIONS

## INSERT THE HEATER ASSEMBLY IN THE WALL CAN

### STEP 4 Wire connections

1. Your heater has two connection wires on the side. Your supply wire has two connection wires and a supply ground wire.

**A.** Connect supply ground wire to grounding screw in wall can (See Figures 3 and 4).

**B.** Connect one supply wire to one heater wire with a wire connector (not included).

For 240 or 208 volts, it doesn't matter which heater wire. Both supply wires (black and white) are hot. Wrap supply (white) wire with black tape to identify it as hot (Figure 3).

For 120 volts, connect the neutral (white) supply wire to the black and white striped heater wire (Figure 4).

**C.** Connect the remaining supply wire to the remaining heater wire with a wire connector (not included) (See Figures 3 and 4).

2. Insert the bottom edge of the heater assembly into the D-shaped tabs at the bottom of the wall can.

3. Push all wires back into the bottom of the wall can. Make sure connections are tight and none of the wires are caught between the motor and the wall can, or pinched between the side of the heater and the wall can.

4. Attach the heater assembly at top of the wall can with screw provided. Align digital display with grill cutout before tightening.

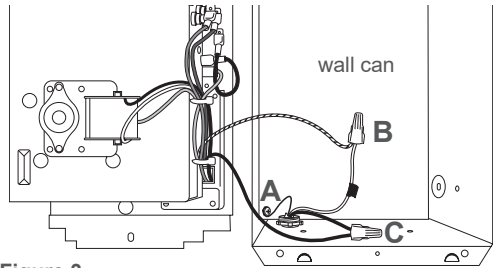

**Figure 3**  
240 Volt

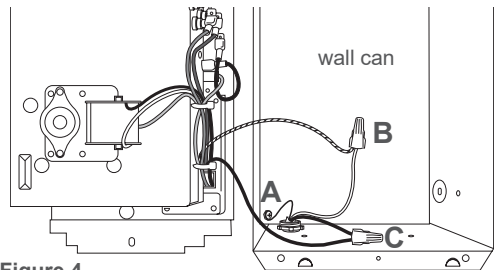

**Figure 4**  
120 Volt

### STEP 5 Install grill

Attach grill with screws provided. Turn electrical power back on at the main disconnect panel.

Wait 10 to 15 seconds for heater to power up before pushing any buttons. After a few seconds, if the heater has been properly installed, the display will flash and show room temperature. The default temperature setting in HEAT mode is 70°F (21.1°C).

Proceed to OPERATING INSTRUCTIONS.

## FAULT CODES

DISPLAY	PROBLEM	SOLUTION
No Display	No power, internal control faulty	Check that power is being supplied to heater. If operating on generator power, confirm generator setting; if display still doesn't turn on, control is faulty. Replace heater assembly.
F1	Grill is interfering with display buttons	Turn power off at main disconnect panel, realign grill. Turn power back on at main disconnect panel.
F4	1. Line voltage is too low 2. Loose wire connections	1. Clears automatically when line voltage returns to normal. 2. Check wire connections.
F6	Line voltage is too high	Clears automatically when line voltage returns to normal.
F8	Internal control fault	Disconnect power, reconnect power. If F8 code returns, control is faulty. Replace heater assembly.
FF	Temperature is below 0°F (-17.8°C), too low to display	Clears automatically when temperature is 0°F (-17.8°C) or above.
FR	Line voltage is too low	Double check voltage supply matches heater voltage rating. A CE168T can only be connected to 208 volts, and a CE162T can only be connected to 240 volts.

# INSTALLATION INSTRUCTIONS

## MULTIPLE HEATERS ON ONE CIRCUIT BREAKER (240 or 208 volts only)

More than one heater can be wired in parallel on the same circuit breaker (be sure to check national and local codes for safety requirements). Additional electrical supply wire and cable clamp connectors are required. The heaters must be in the same room.

Maximum amperage you can put on one circuit breaker is limited to 80% of the circuit breaker capacity.

1. Route the electrical supply wire from the circuit breaker to heater #1. Remove two knockouts and attach two sets of electrical supply wire with two cable clamp connectors (not included) leaving a minimum of 6 inches wire lead—one set from the circuit breaker, the other set to heater #2 (See Figure 5).
2. The two supply ground wires in the wall can of heater #1 need to make a 3-wire connection with the grounding screw. Attach a short copper ground wire to the grounding screw in the wall can. Connect this wire and the two supply ground wires with a wire connector (not included). (See Figure 5).
3. For heater #1, connect each heater wire with one of the supply wires going to the circuit breaker, and one of the supply wires going to heater #2. Each of the wires from heater #1 must have a 3-wire connection. For heater #2, make the connections in the wall can as shown below.

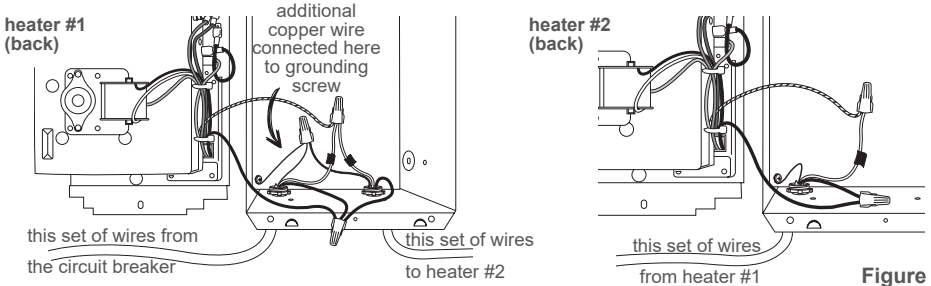
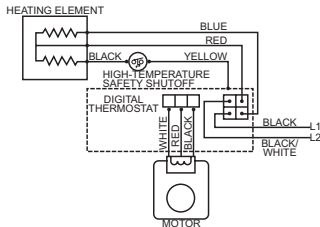

Figure 5

After making all connections, go to Page 5 and proceed with STEP 4 **Finish installation**, number 4.

## INTERNAL HEATER WIRING DIAGRAMS

### CE163T/CE083T Multi-Volt



### CE162T 240 Volt

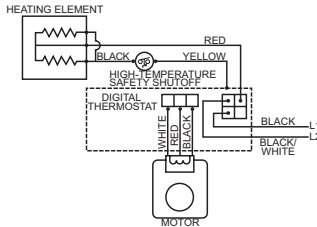

### CE168T 208 Volt

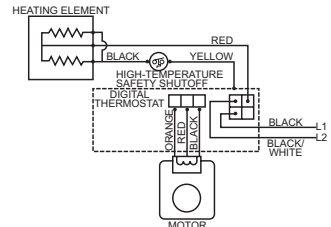

## WARRANTY

For more effective and safer operation and to prolong the life of the heater, read the Owner's Guide and follow the instructions. Failure to properly maintain the heater will void any warranty and may cause the heater to function improperly.

**LIMITED FIVE YEAR WARRANTY:** Cadet will repair or replace any Energy Plus (CE) heater found to be defective within five years after the date of purchase.

**These warranties do not apply:**

1. Damage occurs to the product through improper installation or incorrect supply voltage;
2. Damage occurs to the product through improper maintenance, misuse, abuse, accident, or alteration;
3. The use of unauthorized accessories or unauthorized components constitutes an alteration and voids all warranties. Refer to Cadet website or call customer service at 855.223.3887 or 360.693.2505 for list of authorized accessories and components.

4. Cadet's warranty is limited to repair or replacement.

5. In the event Cadet elects to replace any part of your Cadet product, the replacement parts are subject to the same warranties as the product. The installation of replacement parts does not modify or extend the underlying warranties. Replacement or repair of any Cadet product or part does not create any new warranties.

If you believe your Cadet product is defective, please contact Cadet during the warranty period, for instructions on how to have the repair or replacement processed.

### Parts and Service

Visit [cadetheat.com/parts-service](http://cadetheat.com/parts-service) for information on where to obtain parts and service.

To register your product, visit [cadetheat.com/product-registration](http://cadetheat.com/product-registration)

# OPERATING INSTRUCTIONS

1. Make sure all wires are properly connected and installation is complete before you turn on the heater.
2. Do not operate without grill.
3. Do not tamper with the high-temperature safety shutoff.

## Complete installation

After installation, turn your heater to the highest setting and let it run for 30 minutes. Some smoking may occur as the element initially burns off residue from manufacturing.

If your heater shows signs of overheating, such as glowing red or repeatedly getting unusually hot and shutting off, immediately turn off the circuit breaker and review the "KNOW YOUR VOLTAGE" section or call us.

If the high-temperature safety shutoff trips more than once a day, replace the heater.

Your Energy Plus heater has a variable speed blower that auto adjusts heat output based on the temperature setting. The heater varies wattage output for maximum efficiency. Temperature Range: 40°F to 86°F (4.4°C to 30°C). The room temperature is controlled by the built-in digital thermostat. A wall thermostat cannot be used with this heater.

## Digital Display and Control Buttons

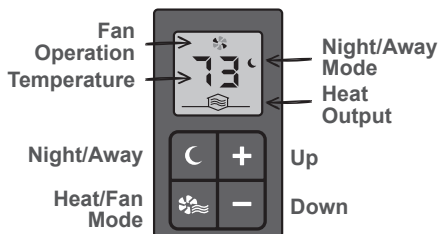

## SWITCHING MODES

Use button to change between modes. In HEAT mode, display shows temperature. In FAN mode, display shows 0, 1, 2 or 3.

## HEAT MODE

Digital display shows room temperature, and the level of heat being output.



## START HEATING/SET TEMPERATURE

- In HEAT mode, press or to adjust temperature.

## FAN MODE

Stops heating, or circulates air without heat.

- In HEAT mode, press . Fan runs at a low level until heater cools down. This lasts for 5 to 10 minutes. When fan stops completely, NO shows in display.
- In FAN mode, press or to adjust fan speed.

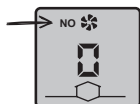

Stop Heating /  
No Fan



Fan Only /  
High Speed

## NIGHT/AWAY MODE

Program a lower temperature for energy savings at night, or if you're not in the room.

- In HEAT mode, press . Display shows moon icon.
- Press or to adjust temperature. The default low temperature is 55°F (12.8°C).
- Fan runs at a low level until heater cools down. This lasts for 5 to 10 minutes.



Night / Away  
Mode

To exit NIGHT/AWAY mode when you wake or return, press .

## MAX/MIN TEMPERATURE LOCK

Program maximum and/or minimum temperature settings as a child safety or tamper-proof option.

MAXIMUM 86°F (30°C):

- In FAN mode, press and hold and at the same time, until display shows temperature.
- Release buttons. While temperature alternates with HL, use or to set maximum temperature.

MINIMUM 40°F (4.4°C):

- Press . While temperature alternates with LL, use or to set minimum temperature.

Wait 10 to 15 seconds and display returns to 0. Your settings are saved.

To change the lock temperatures, follow the same instructions.

## CHANGE DISPLAY TO CELSIUS

- In FAN mode, press and hold and at the same time, until display shows temperature.
- Release buttons. Press twice. Display alternates between °F and °C.
- Press to convert to Celsius. Press to convert back to Fahrenheit.
- Wait 10 to 15 seconds and display returns to 0. Your settings are saved.

# MAINTAINING YOUR HEATER

Clean heater at least every 6 months or as required. Do not lubricate motor.

1. Turn off power at the main disconnect panel.
2. Wait for the heater to cool.
3. Remove grill.
4. Wash grill with hot soapy water and dry.
5. Blow air through the heating element with a hair dryer or shop vacuum on blow cycle.
6. Clean the fan with a vacuum cleaner.
7. Replace grill.
8. Turn power back on at the main disconnect panel.

Any service other than cleaning should be performed by an authorized service representative.

## High-temperature safety shutoff

All Energy Plus heaters come with a built-in high-temperature safety shutoff that stops electricity flowing to the heater if it gets too hot inside. See TROUBLESHOOTING below if you're experiencing problems with your heater.

## TROUBLESHOOTING

Symptom	Problem	Solution
Heater smells after installation or not being used.	<ol style="list-style-type: none"> <li>1. Odor from element manufacturing process.</li> <li>2. Dust or lint inside the heater.</li> <li>3. Supply connections are loose.</li> </ol>	<ol style="list-style-type: none"> <li>1. In a new installation, some smoking may occur as the element initially burns off residue from manufacturing. It typically goes away within several hours.</li> <li>2. Clean heater (see "MAINTAINING YOUR HEATER" above for instructions).</li> <li>3. Turn off power at main disconnect panel. Inspect and/or tighten all the wire connectors inside the heater and at any connection points.</li> </ol>
Heater doesn't work at all.	<ol style="list-style-type: none"> <li>1. Supply connections are loose.</li> <li>2. Heater has tripped its built-in high-temperature safety shutoff and electricity has stopped flowing to the heater.</li> <li>3. Circuit breaker is faulty.</li> <li>4. Heater is in FAN mode at <math>\square</math> setting.</li> <li>5. Defective digital thermostat.</li> </ol>	<ol style="list-style-type: none"> <li>1. Turn off power at main disconnect panel. Inspect and/or tighten all the wire connectors inside the heater and at any connection points.</li> <li>2. TO RESET: Turn power off at main disconnect panel. Allow 10 minutes to cool. Make sure heater is not blocked and is clean. Push reset button. Restore power. If the high-temperature safety shutoff trips more than once a day, replace the heater.</li> <li>3. Call a licensed electrician.</li> <li>4. Press mode button to switch to HEAT mode (display shows room temperature).</li> <li>5. Replace the heater.</li> </ol>
Breaker trips immediately after installing heater.	<ol style="list-style-type: none"> <li>1. A short circuit exists in the electrical supply wires or heater wiring.</li> <li>2. Circuit is overloaded.</li> <li>3. Circuit breaker is faulty.</li> </ol>	<ol style="list-style-type: none"> <li>1. An incorrect connection in the heater or electrical supply wires may cause sparking or arcing. Inspect all heater and electrical supply wiring insulation for damage or call an electrician.</li> <li>2. Use a lower wattage heater, or reduce the number of heaters on the circuit.</li> <li>3. Call a licensed electrician.</li> </ol>
Heater blows cold air or doesn't get hot.	<ol style="list-style-type: none"> <li>1. Element has failed.</li> <li>2. Heater is in FAN mode at <math>\square</math> setting.</li> <li>3. Make sure temperature lock has not been set. Thermostat setpoint range is 40°F to 86°F (4.4°C to 30°C).</li> </ol>	<ol style="list-style-type: none"> <li>1. Replace heater.</li> <li>2. Press mode button to switch to HEAT mode (display shows room temperature).</li> <li>3. See MAX/MIN TEMPERATURE LOCK on page 7.</li> </ol>
Fan/motor doesn't spin.	<ol style="list-style-type: none"> <li>1. Defective motor or motor out of alignment.</li> </ol>	<ol style="list-style-type: none"> <li>1. Replace motor.</li> </ol>
Heater doesn't turn off.	<ol style="list-style-type: none"> <li>1. Heater continues to run but only at a low speed.</li> <li>2. Incorrect heater wattage for room size.</li> </ol>	<ol style="list-style-type: none"> <li>1. If desired room temperature is being maintained, a slower fan, and lower heat output are normal for this heater in its energy saving mode.</li> <li>2. Install additional heaters if circuit allows.</li> </ol>
Built-in high-temperature safety shutoff keeps tripping.	<ol style="list-style-type: none"> <li>1. Airflow is blocked.</li> </ol>	<ol style="list-style-type: none"> <li>1. Remove obstruction(s). Maintain minimum distances (See Page 2).</li> </ol>

**If you are uncomfortable working with electricity, running electrical supply wire or installing a circuit breaker, please consult a licensed electrician.**



### Reduce-Reuse-Recycle

This product is made primarily of recyclable materials. You can reduce your carbon footprint by recycling this product at the end of its useful life. Contact your local recycling support center for further recycling instructions.