

OWNER'S GUIDE



Thank you for your purchase! Question or problem? Let us solve it with a single phone call, email or online chat! We'll save you a trip back to the store!

Cadet Customer Service

Phone: **855.223.3887** (from the US)
800.668.6663 (from Canada)
email: customerservice@cadetheat.com
Live chat: cadetheat.com (contact us)

For how-to videos or more information, please visit:

<http://cadetheat.com/install/fp>

CADET 
INVITING WARMTH

cadetheat.com
855.CADET.US
Vancouver, Washington



tested to UL and CSA standards

IMPORTANT INSTRUCTIONS

⚠ When using electrical appliances, basic precautions should always be followed to reduce the risk of fire, electric shock, and injury to persons, including the following:

1. Read all instructions before installing or using this heater.
2. This heater is hot when in use. To avoid burns, do not let bare skin touch hot surfaces. Keep combustible materials, such as furniture, pillows, bedding, papers, clothes, etc. and curtains at least 3 feet (0.9 meters) from the front of the heater and keep them away from the sides.
3. Extreme caution is necessary when any heater is used by or near children or invalids and whenever the heater is left operating and unattended.
4. Do not operate any heater after it malfunctions. Disconnect power at service panel and have heater inspected by a licensed electrician before reusing.
5. Do not use outdoors.
6. To disconnect heater, turn control(s) to off, and turn off power to heater circuit at main disconnect panel.
7. Do not insert or allow foreign objects to enter any ventilation or exhaust opening as this may cause an electric shock or fire, or damage the heater.
8. To prevent a possible fire, do not block air intakes or exhaust in any manner.
9. A heater has hot and arcing or sparking parts inside. Do not use it in areas where gasoline, paint, or flammable vapors or liquids are used or stored.
10. Use this heater only as described in this manual. Any other use not recommended by the manufacturer may cause fire, electric shock, or injury to persons.

SAVE THESE INSTRUCTIONS

⚠ KNOW YOUR VOLTAGE! ⚠

If you are uncomfortable working with electricity, running electrical supply wire or installing a circuit breaker, please consult a licensed electrician. Make sure power to the heater is turned off at the main disconnect panel whenever doing any work on a heater. Serious injury or electrocution can result from electric shock.

- **CHECK YOUR BREAKER!** If you're replacing an existing heater, check the labels of the old heater and use the same voltage.

single-pole breaker

120 volt

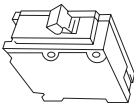

double-pole breaker

240 volt

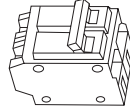

WARNING: Connecting a heater to a voltage higher than what's listed on its rating label will destroy the heater and could start a fire.

A heater will not heat properly when connected to a voltage lower than what's listed on its rating label.

Unanswered questions? Call our technical support team in Vancouver, Washington toll free at **855.223.3887** or outside the USA **360.693.2505**

INSTALLATION INSTRUCTIONS

1. All electrical work and materials must comply with the National Electric Code (NEC), the Occupational Safety and Health Act (OSHA), and all state and local codes.
2. Use copper conductors only.
3. DO NOT install the heater directly above bathtub or sink. DO NOT install in shower stall area. (Manufacturer recommends a minimum 2 foot (61 cm) clearance to prevent contact with water).
4. A GFCI protected branch circuit is recommended when installed in a wet or damp area.
5. Heater must be installed against a rigid surface.
6. DO NOT install the heater anywhere the air discharge may be blocked in any manner.
7. To reduce the risk of fire, do not store or use gasoline or other flammable vapors and liquids in the vicinity of the heater.
8. Connect grounding lead to grounding screw provided. Keep all foreign objects out of heater.

TOOLS REQUIRED

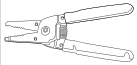

Wire Strippers



Wire Connectors

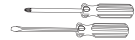

Appropriate Screws

Straight and Phillips
Screwdrivers

Drill and Drill Bits

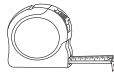

Tape Measure

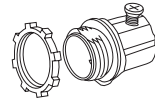
1/2" Conduit
Connector

Volt Meter

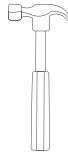

Hammer



Stud Finder

PARTS OF YOUR HEATER

TOP VIEW (FP102 PICTURED)

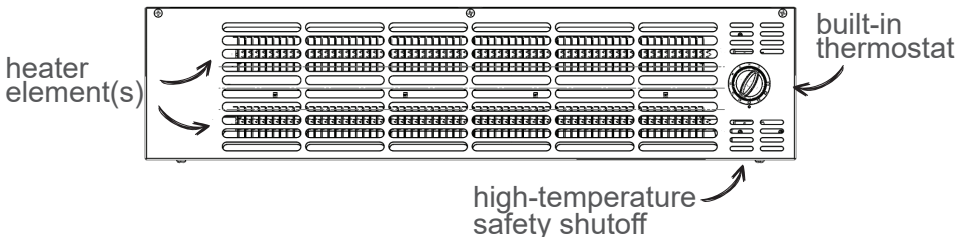

INSTALLATION INSTRUCTIONS

OVERVIEW

This heater is specifically designed for frost protection. In accordance with the National Electrical Code (NEC), ANSI/NFPA 70, it is approved for use in unclassified (non-hazardous) locations such as pump houses, equipment buildings and crawlspaces. It is not approved for residential heating.

Models FP052TB and FP102TB can be connected to 240 or 208 volts.

Model FP051TB is for 120 volts only. Please don't assume you have 120 volts because your wires are black and white.

This heater must be installed by a licensed electrician in accordance with these instructions and all local codes, or in their absence, in accordance with the latest editions of the International Residential Code and International Electrical Code. Always disconnect the heater from its power source before servicing. Ensure that the heater is installed in a location to allow ease of access for repair and maintenance.

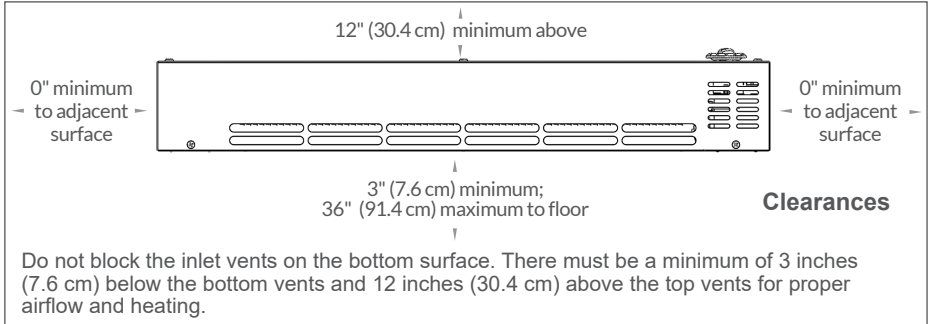

Mount the heater to a rigid, flame resistant wall such as sheet metal, drywall or concrete. There are six holes located on the mounting surface of the back of the heater. Please use any two holes that are as far apart as practical.

In all applications, the heater must be mounted in a space with adequate venting and ground insulation that meets or exceeds local building codes.

For a crawl space, mount to the concrete foundation wall. The heater may be mounted on brick or concrete block. In the absence of a local building code, the heater can only be mounted with the following conditions in a crawl space:

1. Only crawl spaces under home residences shall be used.
2. The crawl space floor, ground cover and wall insulating materials must be flame-retardant.

KNOW YOUR VOLTAGE and CHECK YOUR BREAKER!

All heaters require three supply wires. For 120 volt wiring you will have 1 hot, 1 neutral and 1 ground. For 240 and 208 volt wiring you will have 2 hot wires and 1 ground; no neutral needed.

1. Turn off the electrical power supply. If required, install a new circuit breaker and route electrical wires to the heater.
2. Remove the cover. Wire connections are made on the left side of the heater.
3. Install all necessary conduit and connectors (not included). Rigid or flexible conduit may be used. Leave 6 inches (15.2 cm) of available supply wire for connecting to the heater. The field wiring must include a ground wire connected to the inside of the junction box.
4. Pull supply wires through the conduit leaving 6-inch wire leads.
 - Connect one supply wire to one of the heater wires with a wire connector (not included).
 - a. For 240 and 208 volts, it doesn't matter which heater wire you use. Both supply wires (black and white) are hot. Wrap supply (white) wire with black tape to identify it as hot.
 - b. For 120 volts, connect the neutral (white) supply wire to the white heater wire.
5. Connect remaining supply wire to remaining heater wire with a wire connector (not included).
6. Install the cover. Turn power back on at the main disconnect panel.

OPERATING INSTRUCTIONS

1. The heater must be properly installed before it is used.
2. Do not operate without cover.
3. Do not tamper with high temperature safety shutoff.
4. The heater knob has a temperature range of 40°F (4°C) to 85°F (30°C).
5. The heater will not heat if turned fully counter clockwise.

Complete installation

After installation, turn your heater to the highest setting and let it run for 30 minutes. Some smoking may occur as the element initially burns off residue from manufacturing.

If your heater shows signs of overheating, such as glowing red or repeatedly getting unusually hot and shutting off, immediately turn off the circuit breaker and review the "KNOW YOUR VOLTAGE" section or call us.

If the high-temperature safety shutoff trips more than once a day, replace the heater.

How to operate your heater

The heater is controlled with the built-in thermostat located on the right end of the heater. The thermostat has a range from 40°F (4°C) to 85°F (30°C) starting at the second smallest dot.

IMPORTANT: The heater will not operate if set to the smallest dot on the dial.

Since each application is unique, please adjust the thermostat above the second dot to meet your particular requirements. **A wall thermostat cannot be used with this heater.**

MAINTAINING YOUR HEATER

Clean heater at least every 6 months or as required. The heater must be inspected every 6 month or more if conditions warrant it. It is essential that the heater is not operated with an accumulation of dust, dirt or debris on the heater or inside the heating chamber.

CLEANING INSTRUCTIONS

1. Turn off power at the main disconnect panel.
2. Wait for the heater to cool.
3. Remove the cover and clean with a damp cloth.
4. Carefully clean the heating chamber with a vacuum. Do not touch the heating element fins.
5. Replace and secure the cover.
6. Turn power back on at the main disconnect panel.

Any service other than cleaning should be performed by an authorized service representative.

High-temperature safety shutoff

All Frost Protection heaters come with a built-in high-temperature safety shutoff that stops electricity flowing to the heater if it gets too hot inside. This automatically resets after cooling.

INTERNAL HEATER WIRING DIAGRAMS

FP051T FP052T (single element)

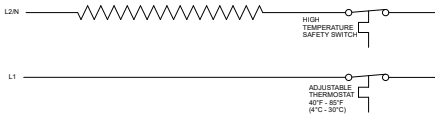

FP102T (dual element)

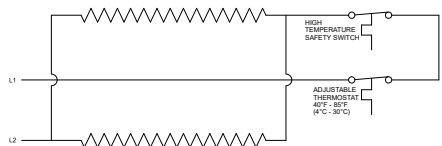

WARRANTY

For more effective and safer operation and to prolong the life of the heater, read the Owner's Guide and follow the instructions. Failure to properly maintain the heater will void any warranty and may cause the heater to function improperly.

LIMITED TWO-YEAR WARRANTY: Cadet will repair or replace any Frost Protection (FP) heater found to be defective within two years after the date of purchase.

These warranties do not apply:

1. Damage occurs to the product through improper installation or incorrect supply voltage;
2. Damage occurs to the product through improper maintenance, misuse, abuse, accident, or alteration;
3. The use of unauthorized accessories or unauthorized components constitutes an alteration and voids all warranties. Refer to Cadet website or call customer service at 855.223.3887 or 360.693.2505 for list of authorized accessories and components.

4. Cadet's warranty is limited to repair or replacement.

5. In the event Cadet elects to replace any part of your Cadet product, the replacement parts are subject to the same warranties as the product. The installation of replacement parts does not modify or extend the underlying warranties. Replacement or repair of any Cadet product or part does not create any new warranties.

If you believe your Cadet product is defective, please contact Cadet during the warranty period, for instructions on how to have the repair or replacement processed.

Parts and Service

Visit cadetheat.com/parts-service for information on where to obtain parts and service.

If you are uncomfortable working with electricity, running electrical supply wire or installing a circuit breaker, please consult a licensed electrician.



Reduce-Reuse-Recycle

This product is made primarily of recyclable materials. You can reduce your carbon footprint by recycling this product at the end of its useful life. Contact your local recycling support center for further recycling instructions.

To register your product, visit cadetheat.com/product-registration